

E042NSL827CSS | Keplero Quantum 90

Recessed professional projector with an adjustable optical unit

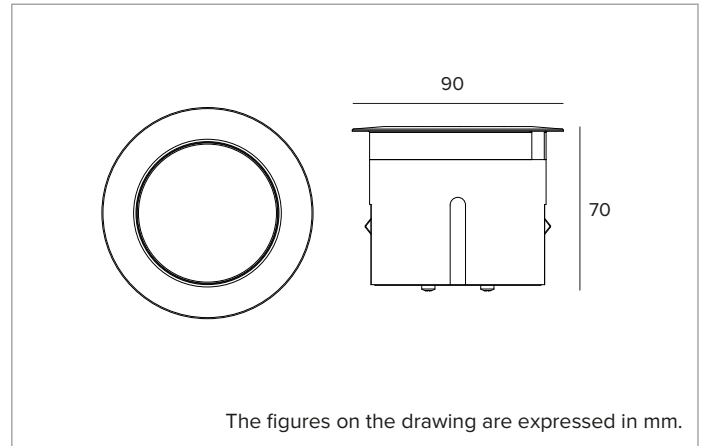

	2700K	H(m)	D(m)	E _{max} (lx)
	Ra80		9°	
Fixture Power	5W	1	0.15	8532
Source Flux	501lm	2	0.30	2133
Fixture Flux	283lm	3	0.45	948
Efficacy	57lm/W	4	0.60	533
TS2221 I _{max} =17030cd/klm	I _{max} 8532cd	5	0.76	341



SOURCE

High efficiency Chip on Board LED. 2700K (Ra80) colour temperature.

Energy efficiency class: E

Nominal power: 4,5W

Nominal flux: 501lm

Colour rendering index: 80

Rf: 80

Rg: 97

CCT nominal: 2700K

ILLUMINOTECHNICAL CHARACTERISTICS

Optical grade PMMA lens and holographic diffusing filter. Version with honeycomb anti-glare grid. Adjustability of the optical unit up to 15° on the vertical plane. Tilting of the optical unit made through external regulation without opening the product.

Optic: LENS

Beam angles: NSP

Optical efficiency: 56%

Fixture flux: 283lm

Luminous efficacy: 57lm/W

Photobiological safety: Compliant with RG1 low risk group

MECHANICAL CHARACTERISTICS

Aluminium body made by CNC machining process and treated with black anodizing. Ultra flat decorative ring with a flared edge, made of brushed stainless steel (AISI 316) in a natural finish. Extra clear protective glass.

Colour and finish: Brushed stainless steel

Version: CLEAR GLASS

Degree of protection: IP66,IP67,IP68

Mechanical Resistance: IK10

ELECTRICAL CHARACTERISTICS

24Vdc power supply. ON-OFF or DALI2 remote driver to be ordered separately. Precabled with 1,5m 2x0,5mm² cable. Casambi control system available via accessory (for products with DALI2 driver only).

Fixture Power: 5W

Power supply: 24Vdc

Insulation Class: CLASS 3

Driver included: NO

Class F: YES

Ambient temperature: -25°C / +35°C

INSTALLATION

In-ground installation by a reinforced nylon sleeve, to be ordered separately. Sleeves are available for flush or trim installation. 20kN resistance to static load. Wall/ceiling installation by the accessory mounting systems.

NOTES

IP68: the fixture is not suitable for permanent underwater installation but can withstand temporary accidental immersion to a depth of 1.5 metres (max.1h). All the Keplero Quantum 90 versions (except all-glass versions) meet the drive-over and walk-over requirements set out in the EN 60598-2-13 standard. Low temperatures on the glass make them suitable even for installation in "special areas", such as spaces for children. It features the "Waterblock Smart" technical solution which involves resin-sealing the connection cables to minimize the risk of moisture rising into the fixture. Commissioning of the control system via free APP; the intervention of a specialist technician can be quoted on request.

WARRANTY

5 years.

WARNING

Luminaire designed for disposal/recycling at end-of-life. Replaceable (LED only) light source by a professional. Non-replaceable control gear.

Due to the technological evolution of the electronic components, the data provided may be updated, and as such, confirmation must be requested during the order process.

Luminous flux and power supply have +/-10% tolerances with respect to the indicated value. tq +25°C (CIE 121).

We reserve the right to make technical changes.

Targetti Sankey S.r.l.
Via Pratese, 164
50145 Firenze - Italy
Tel: +39 055 37911
targetti.com
targetti@targetti.com

CCIAA Firenze
Share Capital:
€ 500.000,00
VAT N. (IT):
01537660480
R.E.A: FI-275656

TARGETTI

E042NSL827CSS | Keplero Quantum 90

Recessed professional projector with an adjustable optical unit

Related codes

Sleeve



L mm	H mm	P mm	Code
219	126	219	A124

Reinforced nylon installation sleeve.
The sleeve is designed for the trim installation of the fixture.
Complete with a cover element to protect the recessed housing during concrete pouring.
Ax/B 219x219 H. 126



L mm	H mm	P mm	Colour	Code
219	127	219		A125SS

Reinforced nylon installation sleeve.
The sleeve is designed for the flush installation of the fixture.
Complete with a cover element to protect the recessed housing during concrete pouring.
Ax/B 219x219 H. 127

Mounting System



Code

A127

Steel spring kit for wall and ceiling installations.

Power Supply

Dimensions LxHxP mm	Power	Power supply	Output voltage	IP	Code
171x37x62	60W MAX	220-240Vac	24Vdc	IP67	A134EL
228x39x68	150W MAX	220-240Vac	24Vdc	IP67	A137EL

Electronic ON-OFF power supply.

Dimensions LxHxP mm	Power	Power supply	Output voltage	IP	Code
150x35x53	60W MAX	220-240Vac	24Vdc	IP67	A134D2
191x38x63	120W MAX	220-240Vac	24Vdc	IP67	A136D2

DALI2 power supply.

Accessories

Connector



Code

1E2493

Linear connection box IP68.
4 poles max. wire section 2.5mm².
Cable diameter range from 7 to 12mm.



Code

1E2494

Multiple connection box IP68.
1 IN - 3 OUT 4 poles max. wire section 2.5mm².
Cable diameter range from 6 to 12mm.

Due to the technological evolution of the electronic components, the data provided may be updated, and as such, confirmation must be requested during the order process.
Luminous flux and power supply have +/-10% tolerances with respect to the indicated value. tq +25°C (CIE 121).

We reserve the right to make technical changes.

Targetti Sankey S.r.l.
Via Pratese, 164
50145 Firenze - Italy
Tel: +39 055 37911
targetti.com
targetti@targetti.com

CCIAA Firenze
Share Capital:
€ 500.000,00
VAT N. (IT):
01537660480
R.E.A.: FI-275656

TARGETTI

E042NSL827CSS | Keplero Quantum 90
Recessed professional projector with an adjustable optical unit

Tool



Code

1E3305

Tightening wrench for the connector kit.

Due to the technological evolution of the electronic components, the data provided may be updated, and as such, confirmation must be requested during the order process.

Luminous flux and power supply have +/-10% tolerances with respect to the indicated value. tq +25°C (CIE 121).

We reserve the right to make technical changes.

Targetti Sankey S.r.l.
Via Pratese, 164
50145 Firenze - Italy
Tel: +39 055 37911
targetti.com
targetti@targetti.com

CCIAA Firenze
Share Capital:
€ 500.000,00
VAT N. (IT):
01537660480
R.E.A: FI-275656

TARGETTI